

ENG: The measurements mentioned in the drawings and in TimberIN websites are only approximate data. They will differ from the measurements of the finished product. It is due to the fact that our products are individually designed and hand-made. However, if one or more measurements are very important, please mention before ordering. We will pay big attention to your requirements in the production process. This will ensure that the product will be produced as closely as possible to your requirements.

DE: Die in den Zeichnungen und auf den TimberIN-Websites genannten Maße sind nur ungefähre Angaben. Sie unterscheiden sich von den Maßen des fertigen Produkts. Dies liegt daran, dass unsere Produkte individuell gestaltet und handgefertigt werden. Wenn jedoch eine oder mehrere Messungen sehr wichtig sind, geben Sie dies bitte vor der Bestellung an. Wir werden Ihre Anforderungen im Produktionsprozess sehr berücksichtigen. Dadurch wird sichergestellt, dass das Produkt so genau wie möglich Ihren Anforderungen entspricht.

FR: Les mesures mentionnées dans les dessins et sur les sites Web TimberIN ne sont que des données approximatives. Ils différeront des mesures du produit fini. Cela est dû au fait que nos produits sont conçus individuellement et fabriqués à la main. Cependant, si une ou plusieurs mesures sont très importantes, merci de le mentionner avant de commander. Nous prêterons une grande attention à vos besoins dans le processus de production. Cela garantira que le produit sera fabriqué aussi près que possible de vos besoins.

DK: Målingerne nævnt på tegningerne og på TimberIN-websteder er kun omtrentlige data. De afviger fra målingerne af det færdige produkt. Det skyldes, at vores produkter er individuelt designet og håndlavet. Hvis en eller flere målinger dog er meget vigtige, skal du nævne det før du bestiller. Vi vil være meget opmærksomme på dine krav i produktionsprocessen. Dette vil sikre, at produktet produceres så tæt som muligt efter dine krav.

NO: Målingene nevnt på tegningene og på TimberIN nettsteder er bare omtrentlige data. De vil avvike fra målingene av det ferdige produktet. Det skyldes det faktum at produktene våre er individuelt designet og håndlaget. Imidlertid, hvis en eller flere målinger er veldig viktige, må du nevne før du bestiller. Vi vil ta stor vekt på dine krav i produksjonsprosessen. Dette vil sikre at produktet blir produsert så nært som mulig dine behov.

IT: Le misure menzionate nei disegni e nei siti Web di TimberIN sono solo dati approssimativi. Differiranno dalle misure del prodotto finito. È dovuto al fatto che i nostri prodotti sono progettati e realizzati a mano individualmente. Tuttavia, se una o più misurazioni sono molto importanti, si prega di menzionare prima di ordinare. Presteremo grande attenzione alle vostre esigenze nel processo di produzione. Ciò garantirà che il prodotto sarà prodotto il più vicino possibile alle vostre esigenze.

NL: De in de tekening en op TimberIN-websites genoemde metingen zijn slechts benaderende gegevens. Ze zullen verschillen van de afmetingen van het eindproduct. Het is te wijten aan het feit dat onze producten individueel zijn ontworpen en met de hand zijn gemaakt. Als een of meer metingen erg belangrijk zijn, vermeld dit dan voordat u bestelt. We zullen veel aandacht besteden aan uw eisen in het productieproces. Dit zorgt ervoor dat het product zo dicht mogelijk bij uw eisen wordt geproduceerd.

SWE: Mätningarna som nämns på ritningarna och på TimberIN-webbplatser är endast ungefärliga data. De kommer att skilja sig från måtten på den färdiga produkten. Det beror på att våra produkter är individuellt designade och handgjorda. Om en eller flera mätningar är mycket viktiga, berätta dock innan du beställer. Vi kommer att ägna stor uppmärksamhet åt dina krav i produktionsprocessen. Detta kommer att säkerställa att produkten produceras så nära dina krav som möjligt.

PL: Pomiarы wymienione na rysunkach i na stronach internetowych TimberIN są jedynie danymi przybliżonymi. Będą się różnić od pomiarów gotowego produktu. Wynika to z faktu, że nasze produkty są indywidualnie zaprojektowane i wykonane ręcznie. Jeśli jednak co najmniej jeden pomiar jest bardzo ważny, należy o tym wspomnieć przed złożeniem zamówienia. Zwrócimy dużą uwagę na Twoje wymagania w procesie produkcyjnym. Zapewni to, że produkt będzie produkowany jak najbliżej Twoich wymagań.

KLEINE BUITENSAUNA VATSAUNA VOOR 2-4 PERSONEN MINI



Inhoudsopgave

PICTOGRAMMEN	4
TERRAS SAUNA 160.....	5
TERRAS SAUNA 160 MET EEN HALVE MAAN VENSTER AAN DE ACHTERKANT	6
TERRAS SAUNA 160 MET EEN GLAZEN VOORWAND.....	7
TERRAS SAUNA 160 MET EEN GLAZEN VOORWAND EN HALF MAAN VENSTER AAN DE ACHTERKANT	8
SAUNA INTERIEUR - EXTERIEUR METINGEN	9
METINGEN VAN DE SAUNA BASIS.....	10

TimberIN

PICTOGRAMMEN



Barrel diameter and length



Material thickness



Material thickness front and back



Material thickness sides



Material thickness front and back



Material thickness sides



Weight



Package size



People



Electrical heater



Door dimensions



Two-sided door dimensions



Window dimensions



Panoramic window dimensions



Round window



Material - spruce



Material - thermowood

TERRAS SAUNA 160



205 Ø x 160 cm



2-4 people



42 mm



169 x 59 cm



28 mm



Electrical heater



Material - spruce



205 x 110 x 110 cm



Material - thermowood



700 kg

TERRAS SAUNA 160 MET EEN HALVE MAAN VENSTER AAN DE ACHTERKANT

TERRACE SAUNA 160

(half-moon glass)



205 Ø x 160 cm



2-4 people



42 mm



169 x 59 cm



28 mm



91,5 x 30 cm



Electrical heater



Material - spruce



205 x 110 x 110 cm



Material - thermowood



700 kg





TERRAS SAUNA 160 MET EEN GLAZEN VOORWAND

TERRACE SAUNA 160

(front glass wall)



 205 Ø x 160 cm

 2-4 people

 42 mm

 169 x 59 cm

 28 mm



 Electrical heater



Material - spruce

 205 x 110 x 110 cm



Material - thermowood



700 kg

TERRAS SAUNA 160 MET EEN GLAZEN VOORWAND EN HALF
 MAAN VENSTER AAN DE ACHTERKANT

TERRACE SAUNA 160

(front glass wall + half-moon glass)



205 Ø x 160 cm



2-4 people



42 mm



169 x 59 cm



28 mm



91,5 x 30 cm



Electrical heater



Material - spruce



205 x 110 x 110 cm



Material - thermowood



700 kg

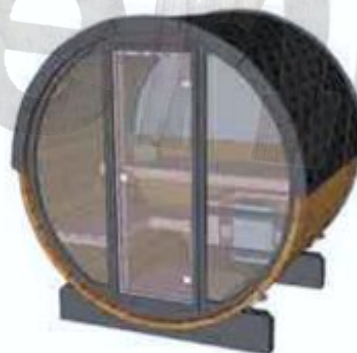

SAUNA INTERIEUR - EXTERIEUR METINGEN

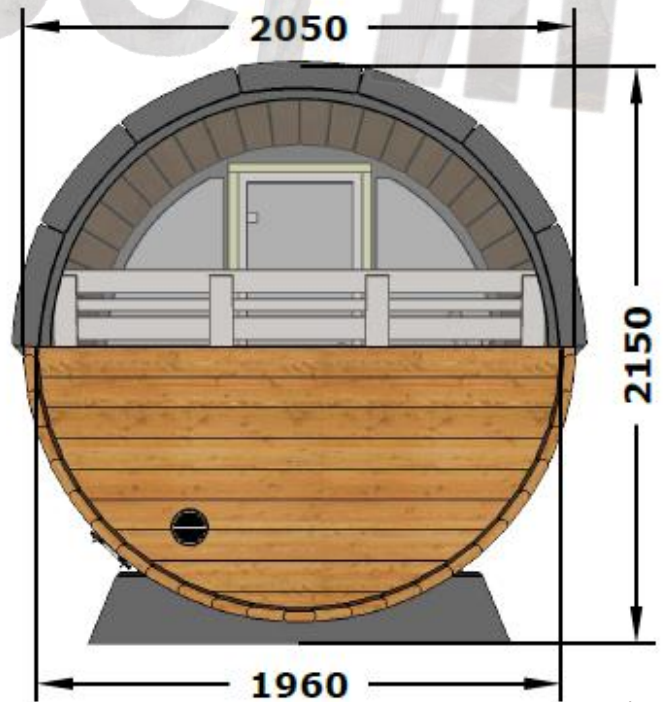
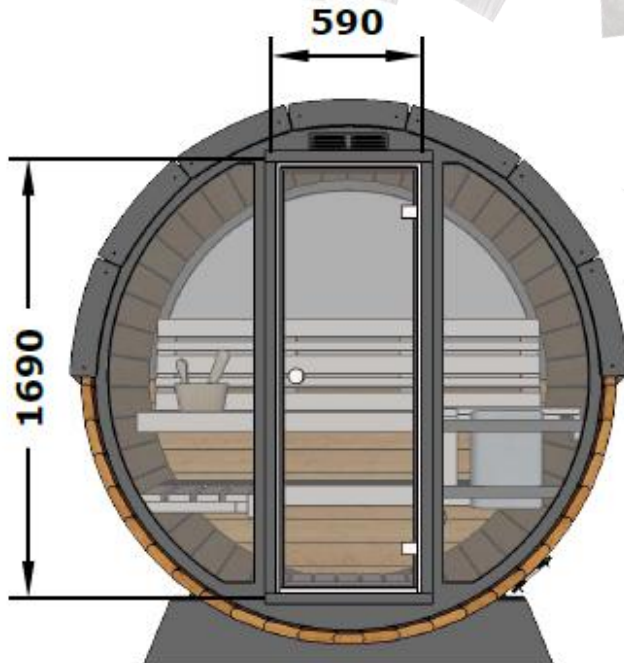
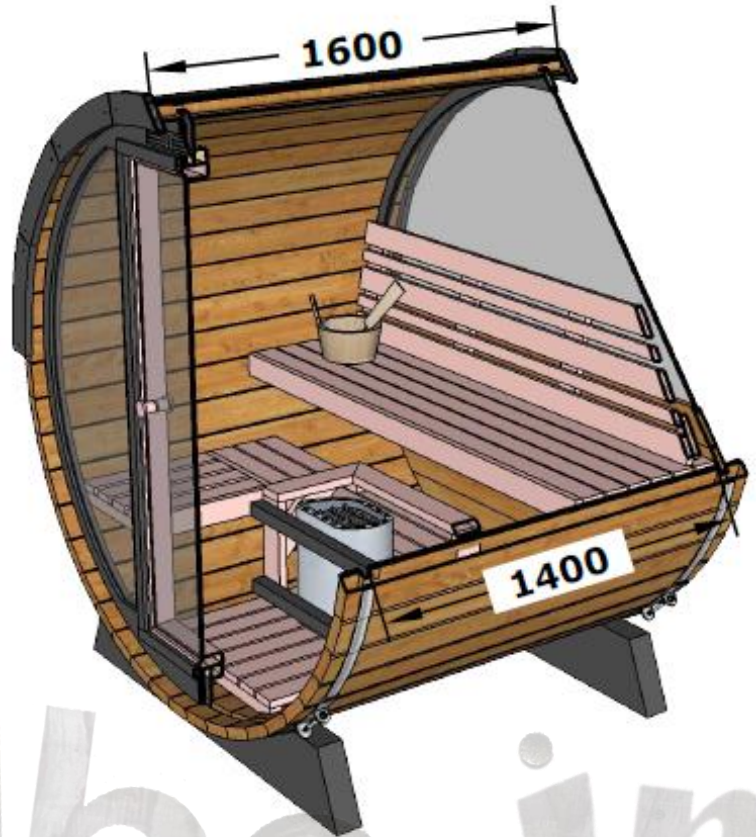
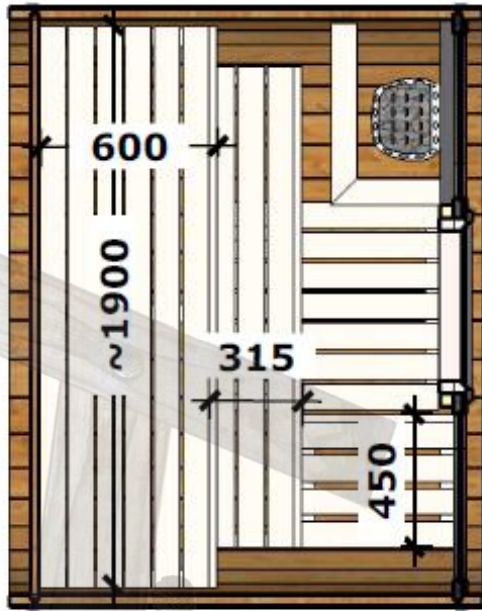

METINGEN VAN DE SAUNA BASIS

Sauna 160, Ø200

